

Laser-Based Detection of Trace-Level Contaminants

Alexandra Hoops, Salvatore Birtola, David Chandler,
Sean Moore, Brian Patterson, Kevin Strecker

NETL 2012 Crosscutting Research Review Meeting - 3/12/12

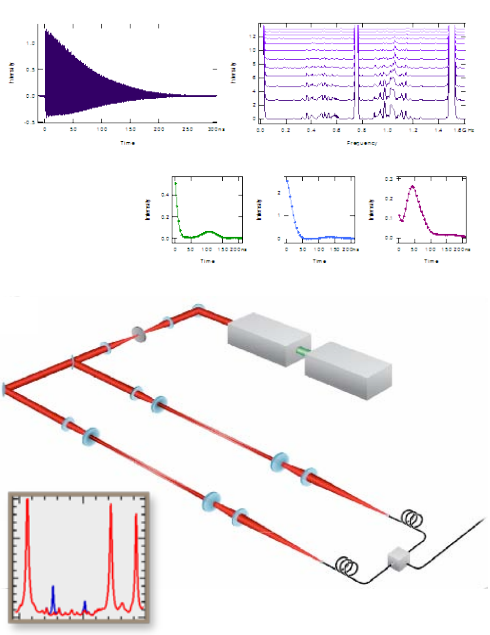
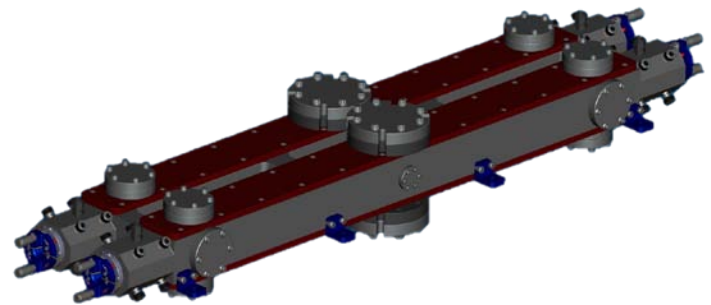

*Exceptional
service
in the
national
interest*



Sandia National Laboratories is a multi-program laboratory managed and operated by Sandia Corporation, a wholly owned subsidiary of Lockheed Martin Corporation, for the U.S. Department of Energy's National Nuclear Security Administration under contract DE-AC04-94AL85000.

- Motivation
- Dual-etalon, frequency-comb cavity ring-down spectrometer
- Proof-of-principle experiments: H₂O, O₂
 - Setup I: broadband laser, low-resolution cavity
 - Setup II: narrowband laser, high-resolution cavity
- Application to HCl detection
 - HCl spectroscopy
 - Component selection and next-generation dual-etalon spectrometer design
- Summary and next steps

- Motivation
- Dual-etalon, frequency-comb cavity ring-down spectrometer
- Proof-of-principle experiments: H_2O , O_2
 - Setup I: broadband laser, low-resolution cavity
 - Setup II: narrowband laser, high-resolution cavity
- Application to HCl detection
 - HCl spectroscopy
 - Component selection and next-generation dual-etalon spectrometer design
- Summary and next steps

- Recently promulgated regulations regarding hazardous-air-pollutant (HAP) emissions from utility coal boilers include:
 - Substantial reductions in allowable emission levels, especially for new plants
 - Increased monitoring and reporting requirements
- Determination of HAP emission limits based on:
 - Environmental and health effects
 - Capabilities of monitoring approaches
- Potential for greater emissions control with advanced sensors that can operate with high-sensitivity, specificity, and with a fast time response
- HCl identified as a key HAP for which current continuous emission monitors (CEMs) are inadequate

- Optical approaches offer high sensitivity and specificity
 - Tunable diode laser spectroscopy
 - Fourier transform infrared spectroscopy (FTIR)
- Detection sensitivities of currently available HCl CEMs
 - Extractive: 0.1 ppm
 - Probe: 0.2 ppm
 - Cross duct: 60 ppm
- Existing technology sufficient to meet monitoring requirements for existing utility coal boilers, but inadequate for new units
- Goal: to develop an *in situ* monitoring approach with detection sensitivity < 0.1 ppm

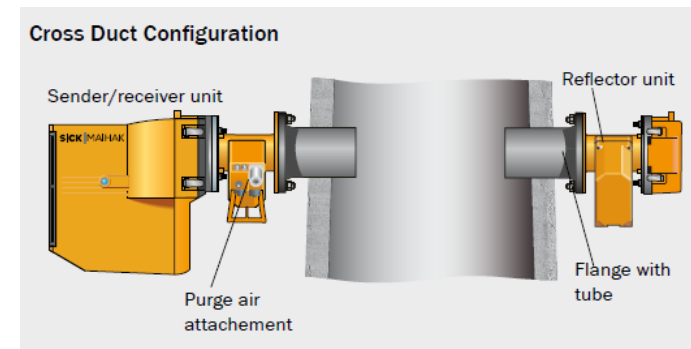
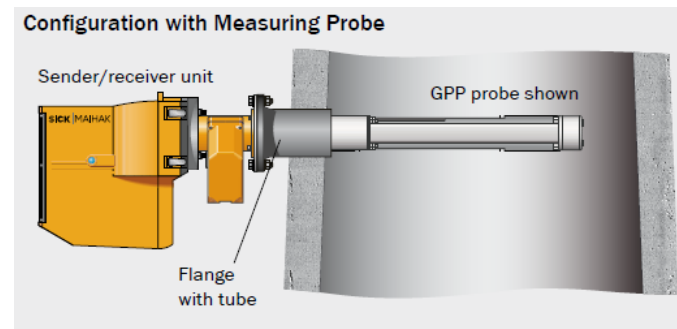

- Motivation
- Dual-etalon, frequency-comb cavity ring-down spectrometer
- Proof-of-principle experiments: H_2O , O_2
 - Setup I: broadband laser, low-resolution cavity
 - Setup II: narrowband laser, high-resolution cavity
- Application to HCl detection
 - HCl spectroscopy
 - Component selection and next-generation dual-etalon spectrometer design
- Summary and next steps

Traditional Cavity Ring-Down Spectroscopy (CRDS)

- Principles of operation:

- Laser pulse is injected into a high finesse cavity and the decay of light intensity, $I(t)$, leaked out of the cavity is monitored:

$$I(t) = I_0 e^{-t/\tau}$$

- Decay constant, τ , of the cavity depends on the mirror reflectivity, scattering, and absorption by the background gas
- Absorption by analyte present in cavity increases decay rate

- Advantages

- High sensitivity: long path length from multiple passes through the cavity
- Ring down time not sensitive to variations in laser intensity

- Key disadvantages

- Observed intensity decay not spectrally resolved → to acquire a spectrum, the laser wavelength must be scanned
- Spectral resolution limited by laser linewidth, necessitating high-quality laser source

Dual-Etalon, Frequency-Comb Cavity Ring-Down Spectroscopy

- New technique* recently developed at Sandia to generate a broad-bandwidth, high-resolution spectrum with the sensitivity of CRDS in a single laser pulse
- Broad bandwidth laser beam directed through two etalon cavities of slightly different lengths
- Output beams are two frequency combs with spacings set by free spectral ranges (FSRs) of etalon cavities
- Difference in spacing between the frequency combs generates beat frequencies when signals from the two cavities are combined
- Absorption spectrum can be reconstituted from the observed interference pattern

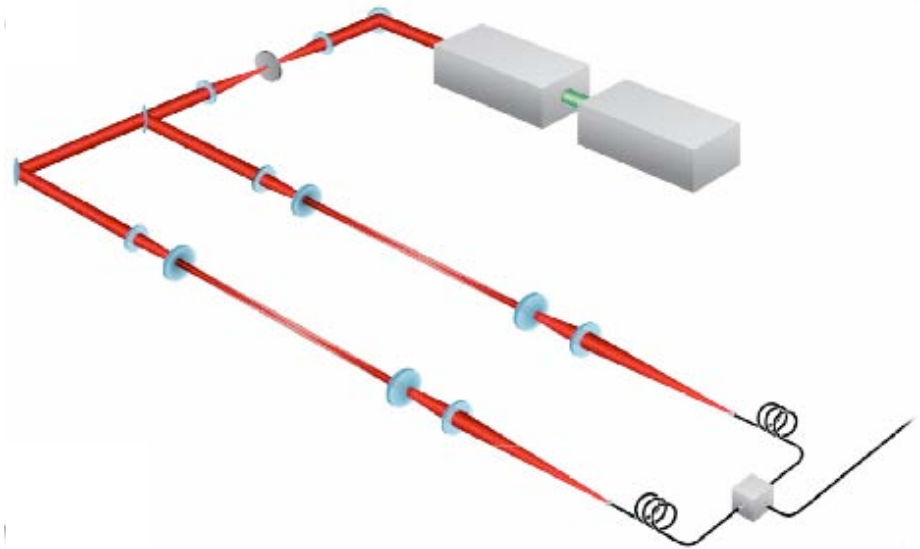

*Patent submitted 2011

Simulated Etalon Output

- Etalon 1 free spectral range: 1.5 GHz
- Etalon 2 offset: 100 MHz

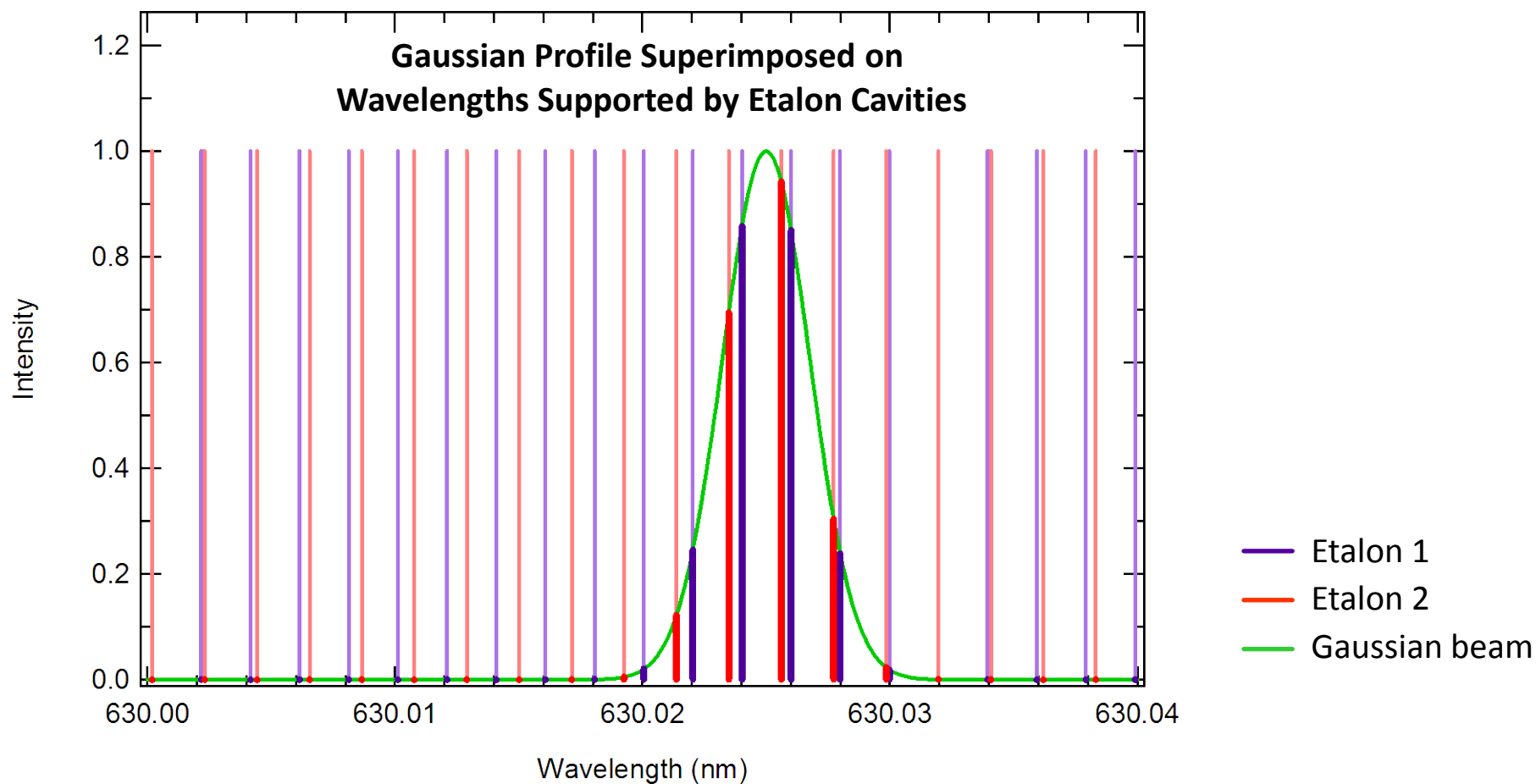

Generation of Beat Frequencies

- Heterodyning two frequency combs results in additional beat frequencies, shifting spectrum to lower frequencies
- Key to high resolution: frequency walk-off of the two combs ensures that each optical frequency corresponds to a unique rf frequency

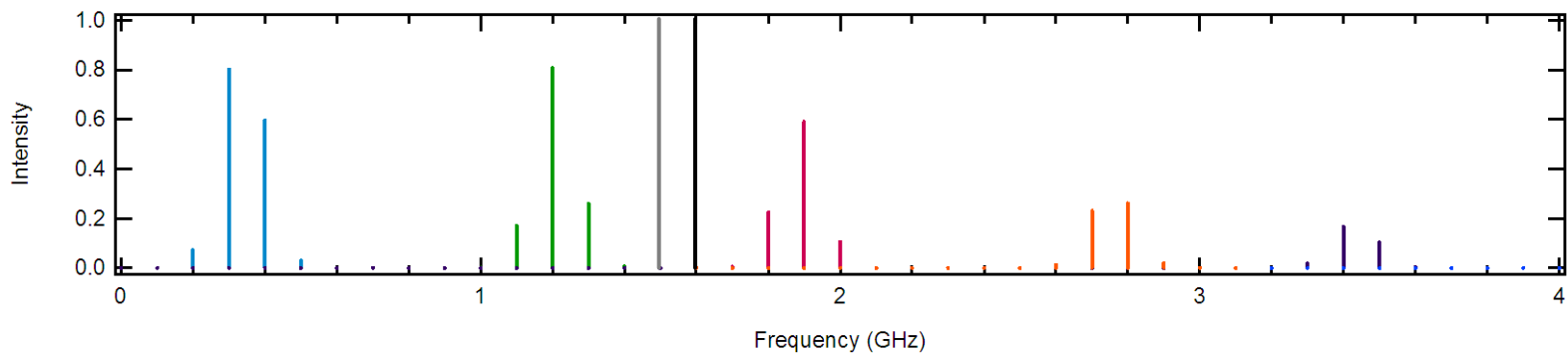
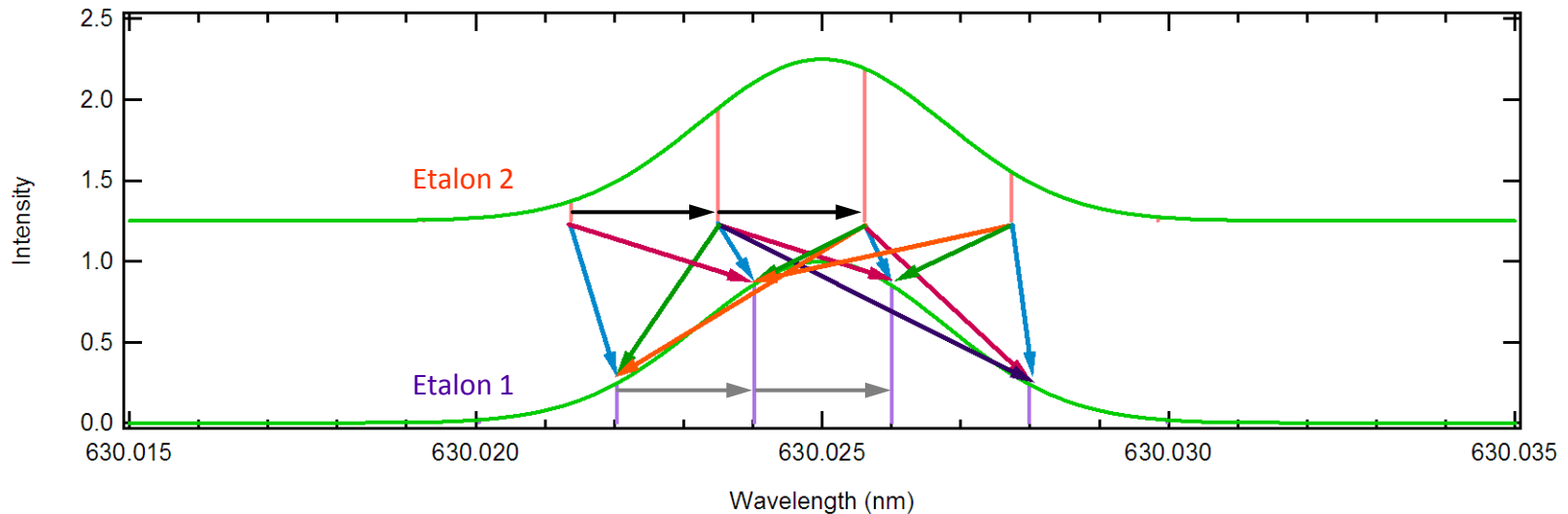

Impact of Etalon FSR Offset

- Simulated Gaussian profile width: 0.1 nm
- Decreasing difference in free spectral ranges of cavities increases width of captured spectrum
- Upper limit: spectral overlap
 - Non-overlapped spectral width: $\text{FSR} \times N_{\text{BF}}$
 - N_{BF} : number of beat frequencies in non-overlapped region ($N_{\text{BF}} = 0.5 \text{ FSR} / \Delta\text{FSR}$)
- Lower limit: resolving power for features of interest (function of ring-down time)

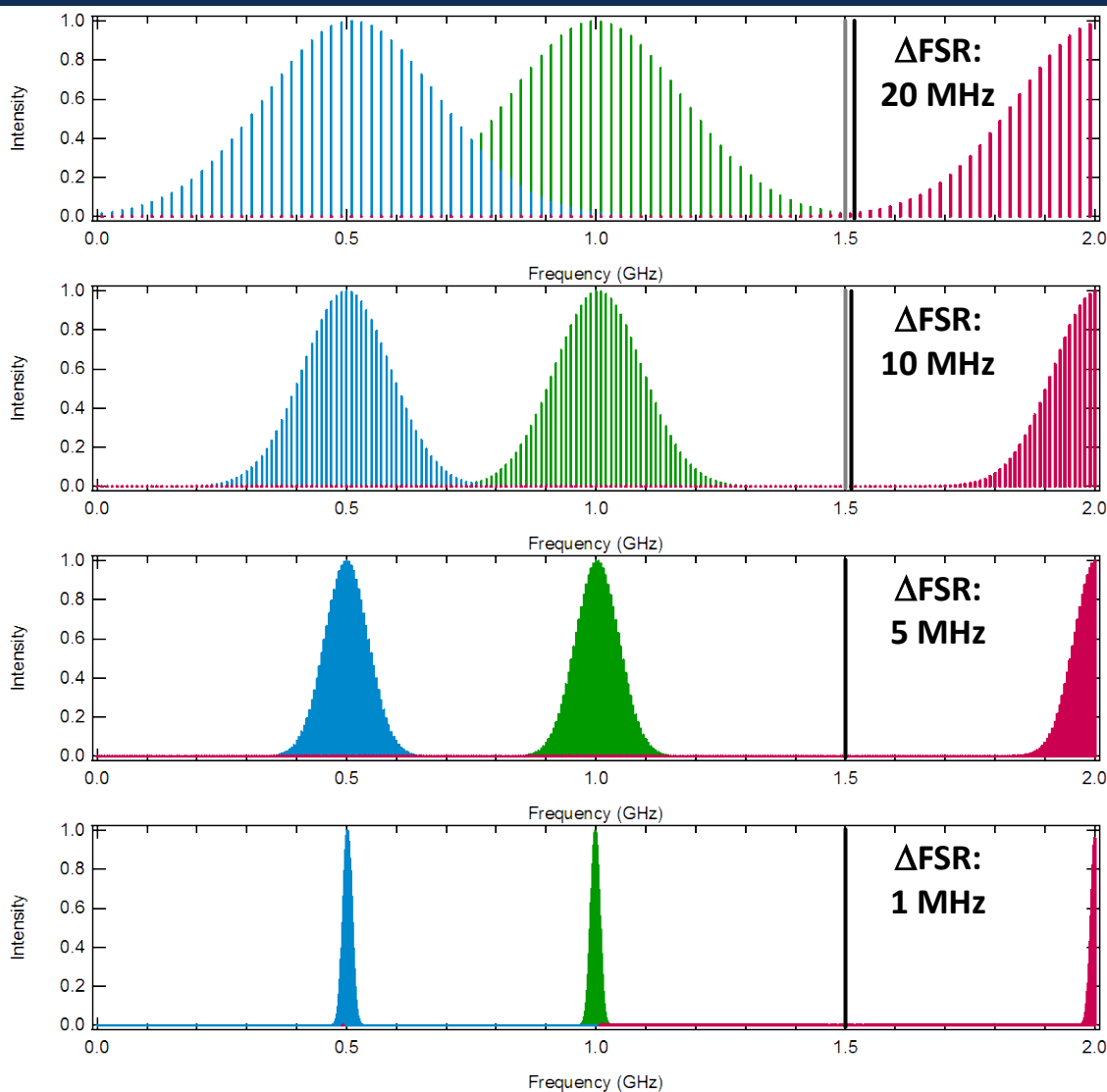

Dual-Etalon, Frequency-Comb CRDS Characteristics

- Width of single-shot spectrum determined by laser bandwidth
- Maximum spectral resolution equals free spectral range of etalons, not laser linewidth
- Laser requirements (spatial beam quality, linewidth, stability) relaxed in comparison to traditional CRDS
- Sensitivity of CRDS with a single laser shot
- Additional sensitivity can be achieved with signal averaging

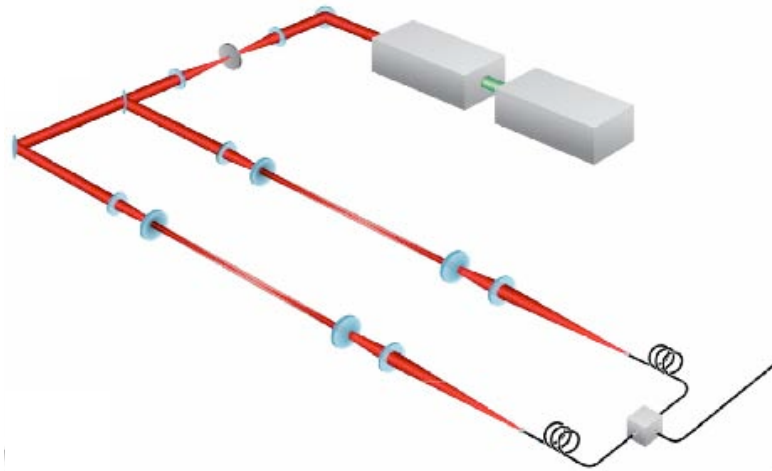

- Motivation
- Dual-etalon, frequency-comb cavity ring-down spectrometer
- Proof-of-principle experiments: H_2O , O_2
 - Setup I: broadband laser, low-resolution cavity
 - Setup II: narrowband laser, high-resolution cavity
- Application to HCl detection
 - HCl spectroscopy
 - Component selection and next-generation dual-etalon spectrometer design
- Summary and next steps

Proof-of-Principle Experiments

- Goal: demonstrate feasibility of dual-etalon, frequency-comb cavity ring-down spectrometer
- Target: weak H_2O absorption overtones accessible with readily available dye lasers

HITRAN-generated H_2O Absorption Spectrum

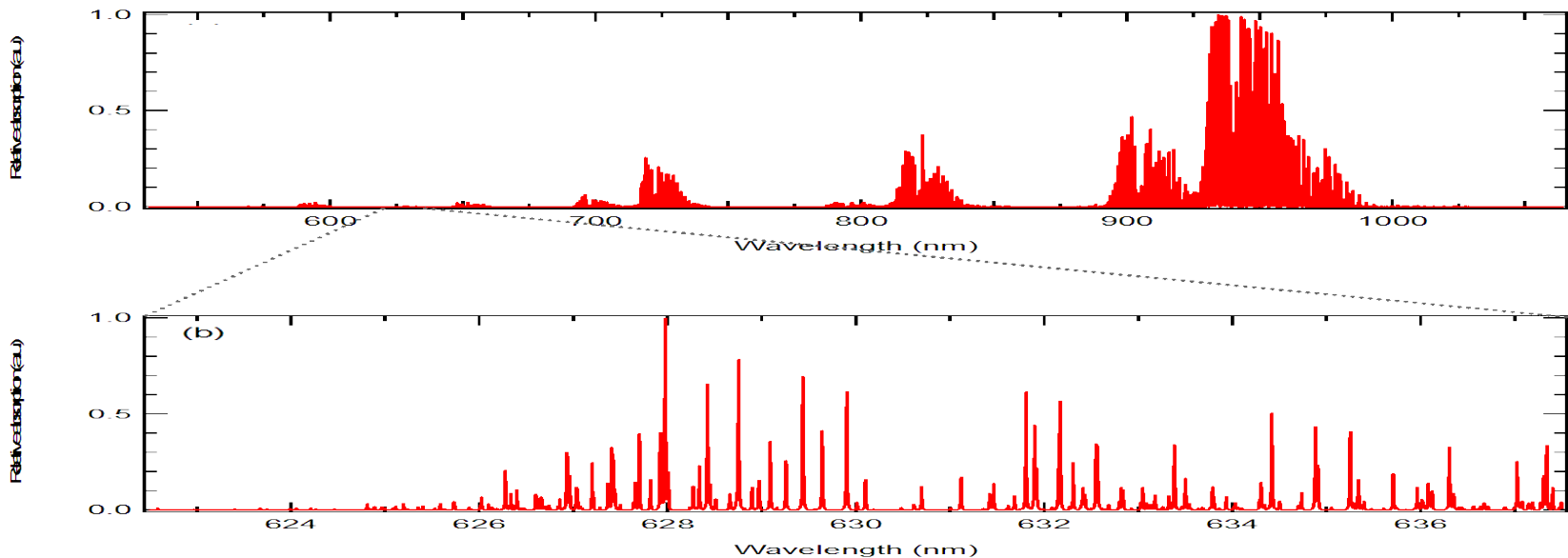

Experimental Setup I

- Laser: amplified broadband dye laser w/DCM
 - Laser thought to lack longitudinal mode structure common in pulsed dye laser systems
 - Pulse energy: 10 mJ
 - Pulse width: 65 ps
 - Repetition rate: 20 Hz
 - Bandwidth: 15 nm
- Bandpass filter to prevent spectral overlap
 - 1 ± 0.2 nm FWHM
 - Center λ : 632.8 nm
 - Peak transmission: 50%
 - Out-of-band transmission (200-1100 nm): <0.01%
- Etalon cavities:
 - Length: 10 cm (1.5-GHz FSR)
 - Mirror reflectivity: >99.5%
 - Confocal configuration: beam collimated in forward direction and focused in cavity center on return
- Fiber coupling for spatial filtering of higher-order cavity modes
- Detector: 1.2-GHz photodiode coupled to 4-GHz oscilloscope

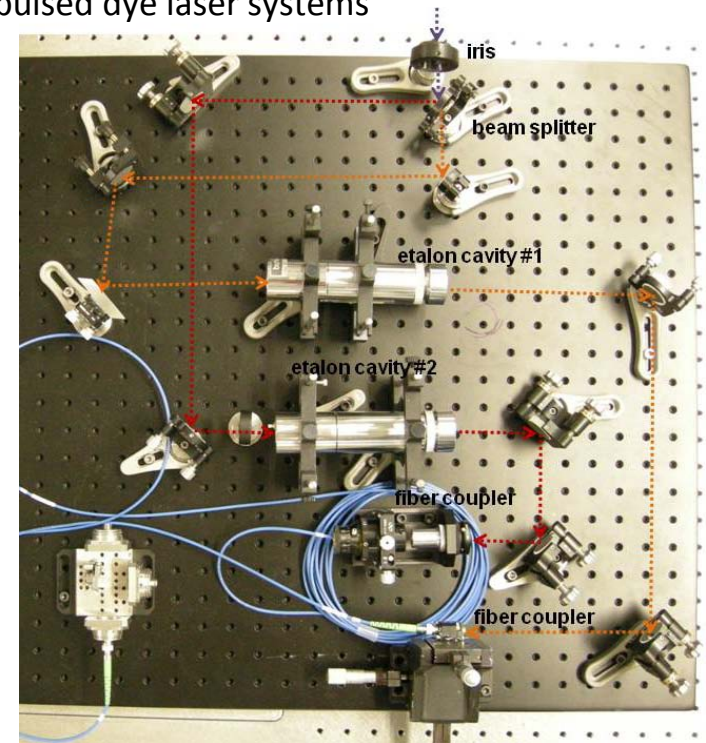

Ring-Down Signals

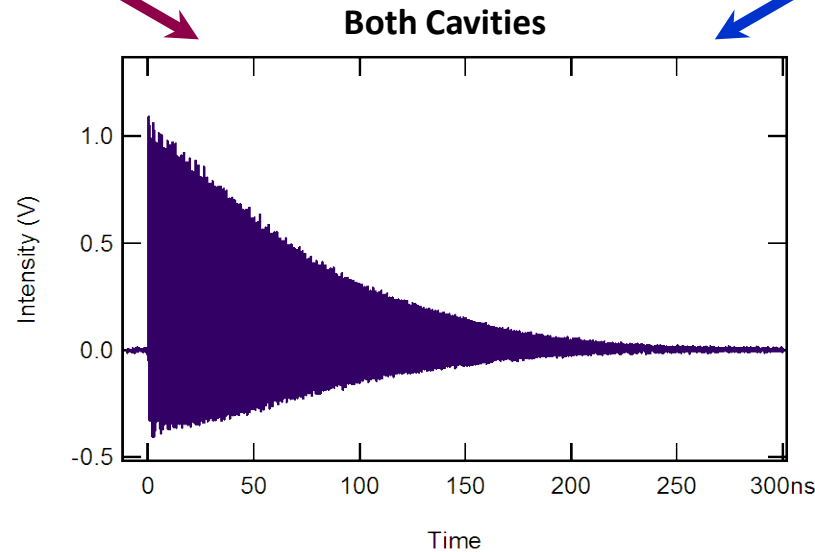
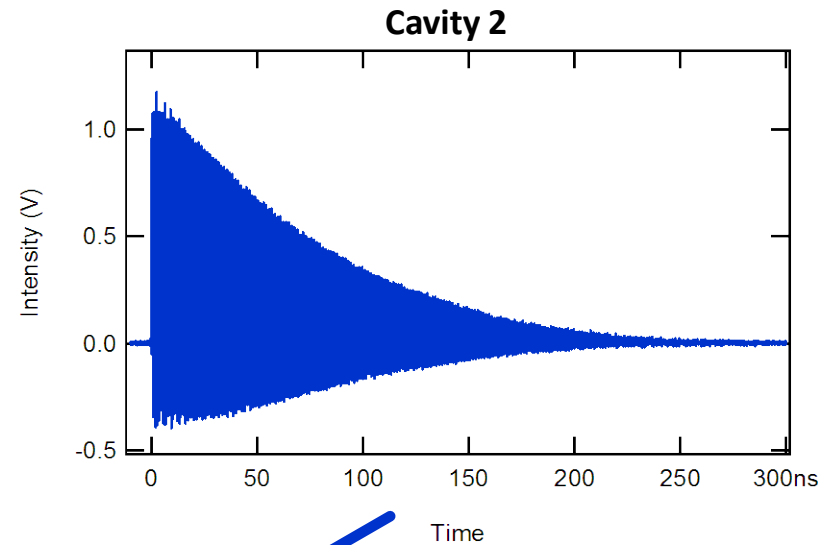
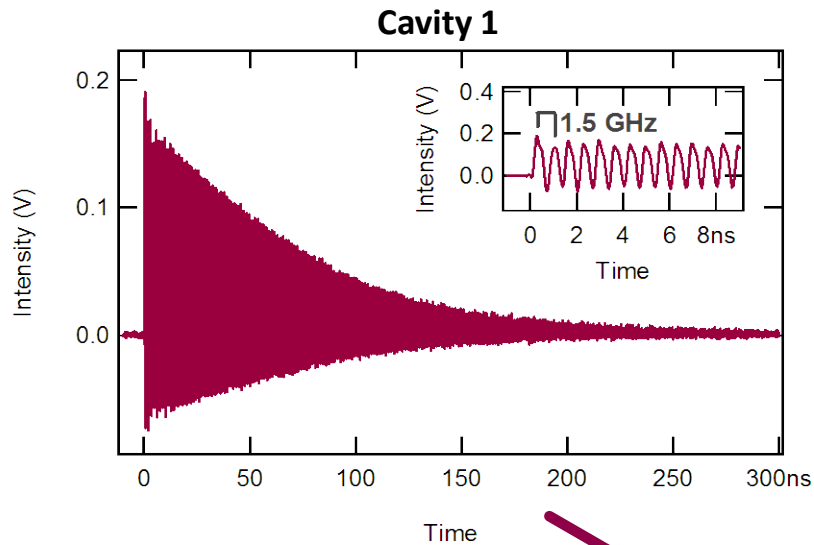

FSR: 1.5 GHz
Fit ring-down decay to:
 $I(t) = I_0 e^{-t/\tau}$
Cavity decay constant:
 $\tau = 75 \text{ ns}$

Interaction of Frequency Combs Apparent in Fourier Transforms of Ring-Down Signals

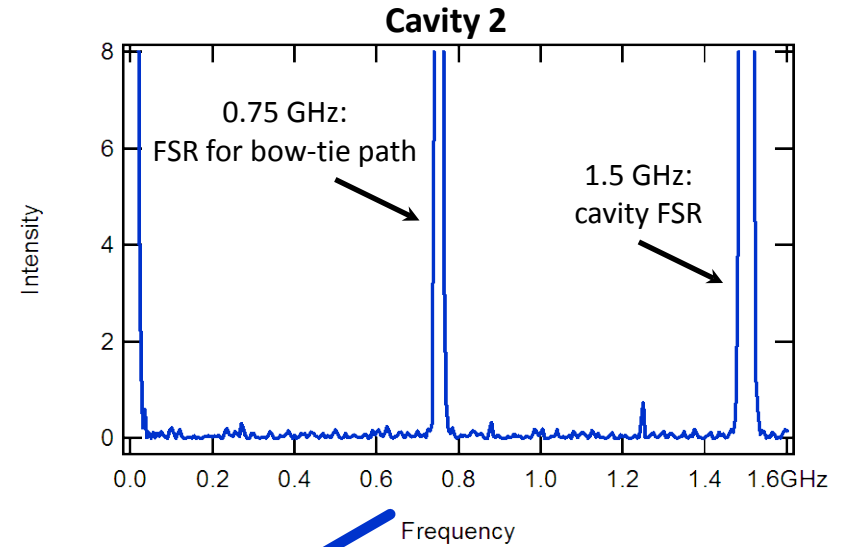
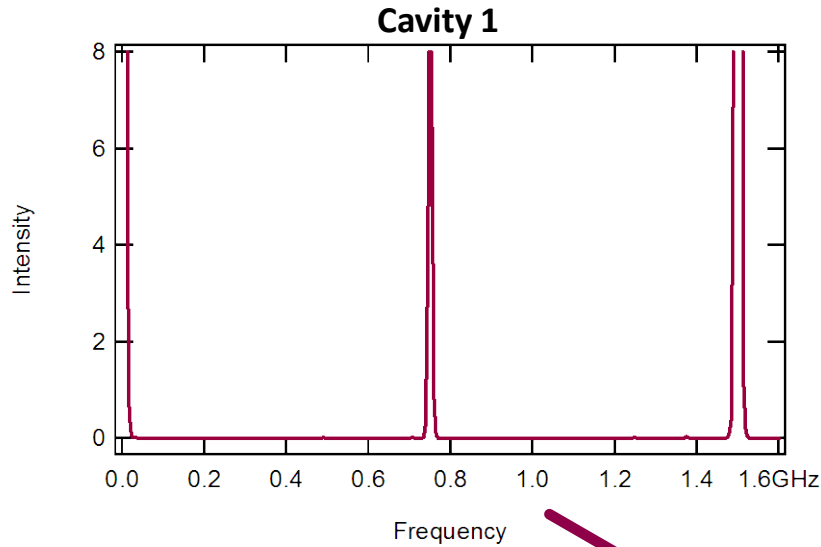

Frequency

Frequency

Both Cavities

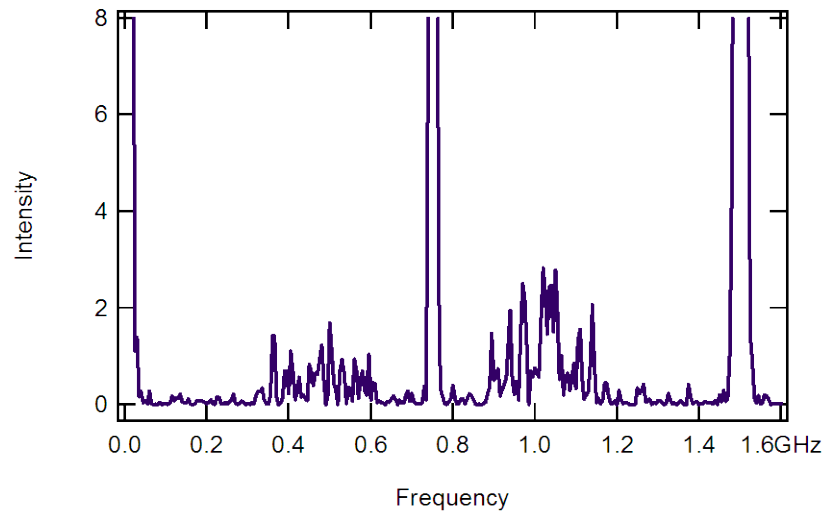

Δ FSR: 700 kHz
 N_{BF} in non-overlapped region:
1,070
Non-overlapped spectral
width: 53.6 cm^{-1} (2.15 nm)

Variable, Structured Laser Intensity Profile

Single Pulse

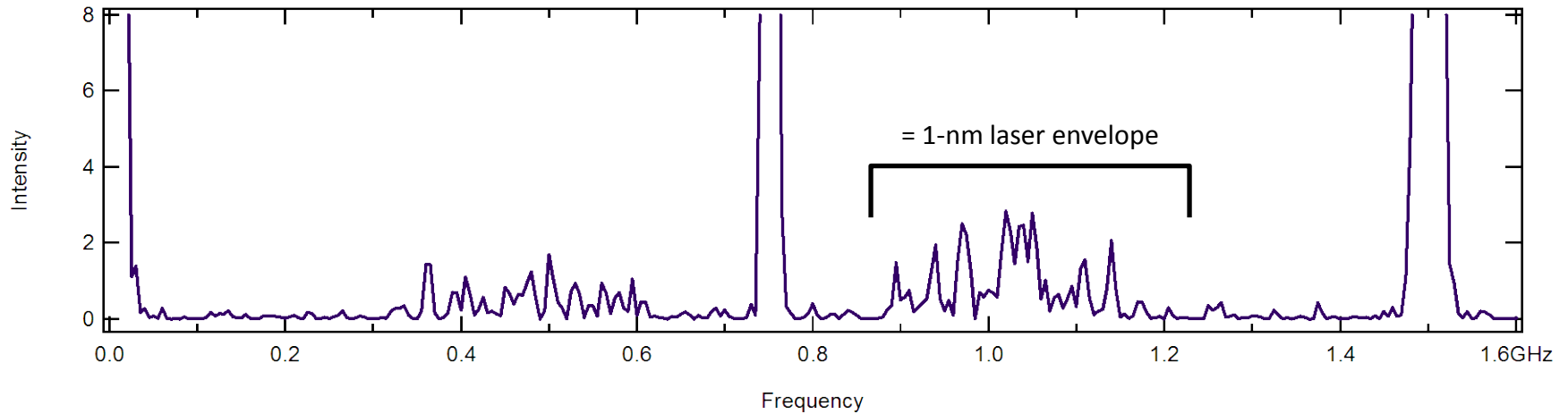

Several Single Pulses

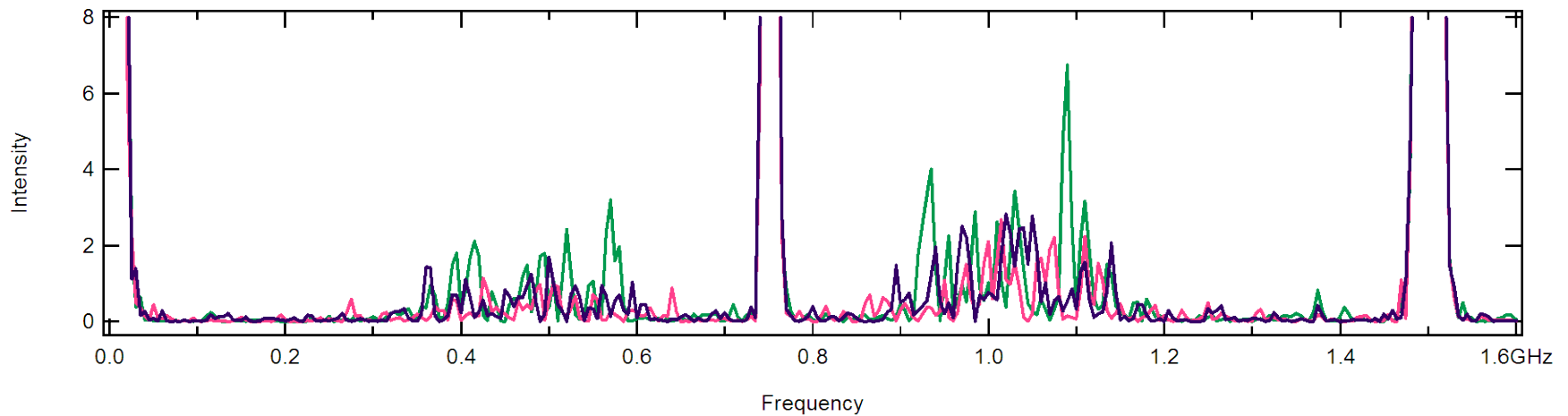

Laser Profile

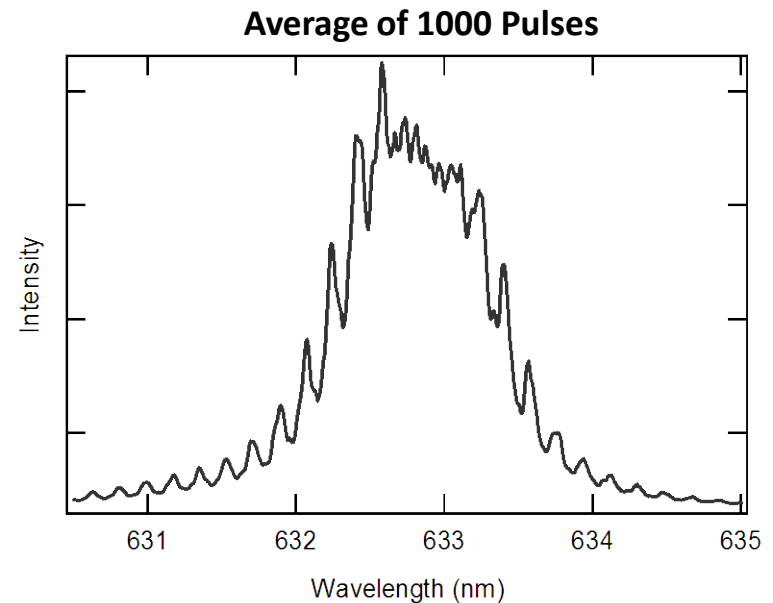
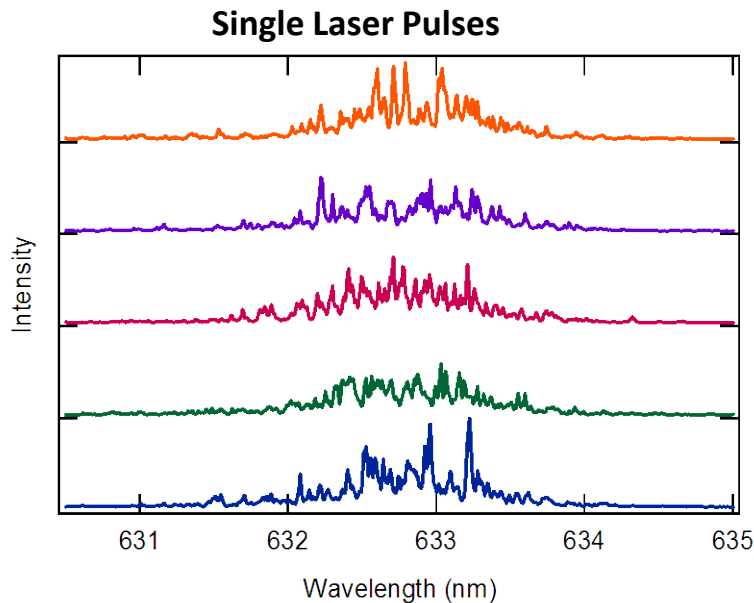

- Independently measure laser profile with 1-m spectrometer
- Confirmation that laser output has considerable structure and pulse-to-pulse variations
- Filtered laser profile:
 - Center λ : 632.8 nm
 - FWHM: 0.98 nm
 - $1/e^2$ full width: 2.0 nm

Data Analysis with Structured Laser Profile: 2 Approaches

- Signal averaging

- With a sufficient number of averages, gaps in laser spectral profile are minimized
- However, an observed drift in signal due to thermal fluctuations impedes simple signal averaging:
 - Simulated Gaussian profile, 1.5-GHz FSR:

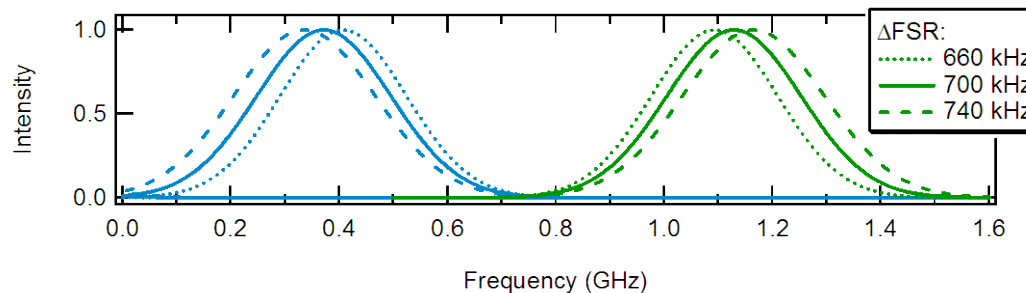

- ± 40 kHz in Δ FSR (± 2.7 μm change in cavity length) causes shift of 36 MHz in Fourier transform (2.5 cm^{-1} shift in wavelength spectrum)
- Measure decay of individual beat frequencies in Fourier transform
 - Cavity ring-down signals independent of laser intensity
 - However, peaks may be missed if the laser power is too low

Examine Decay of Individual Beat Frequencies

Combined Ring-Down Signal

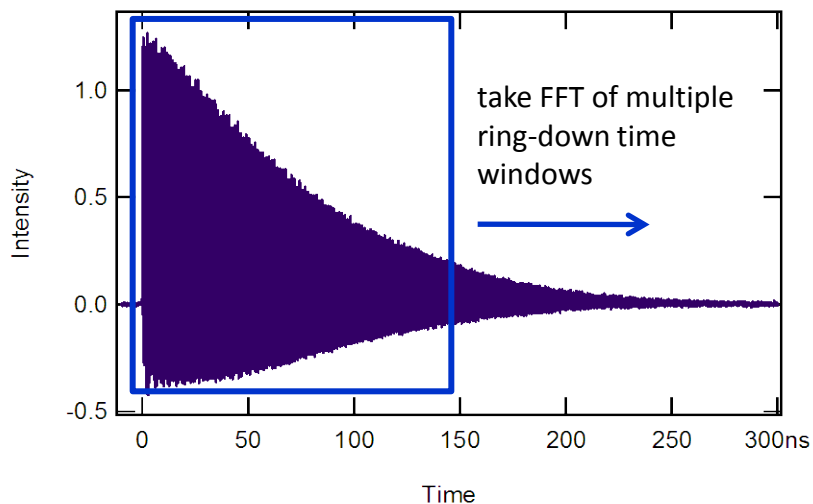

FFT of Ring-Down Sections

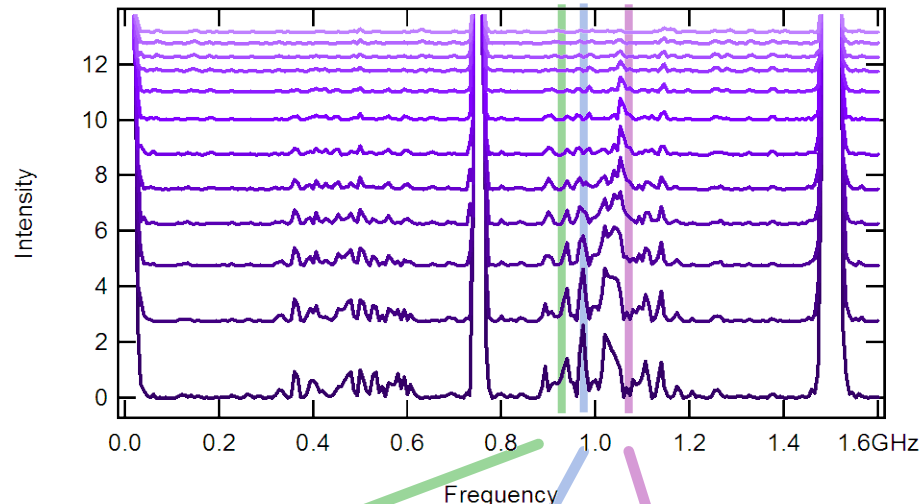

Decay of Individual Beat Frequencies

Fit decay signal to:

$$I(t) = I_0 \exp[-t (1/\tau + \alpha c)]$$

α : absorbance

c : speed of light

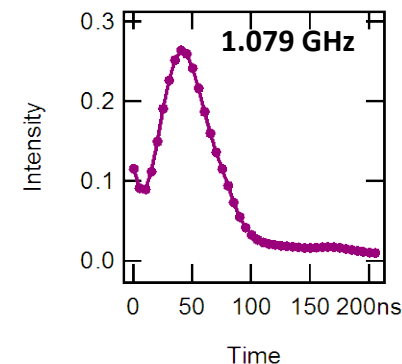
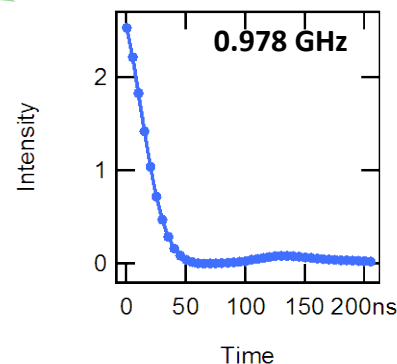
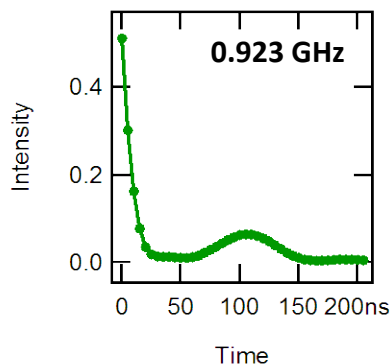

Absorption Spectra of Air

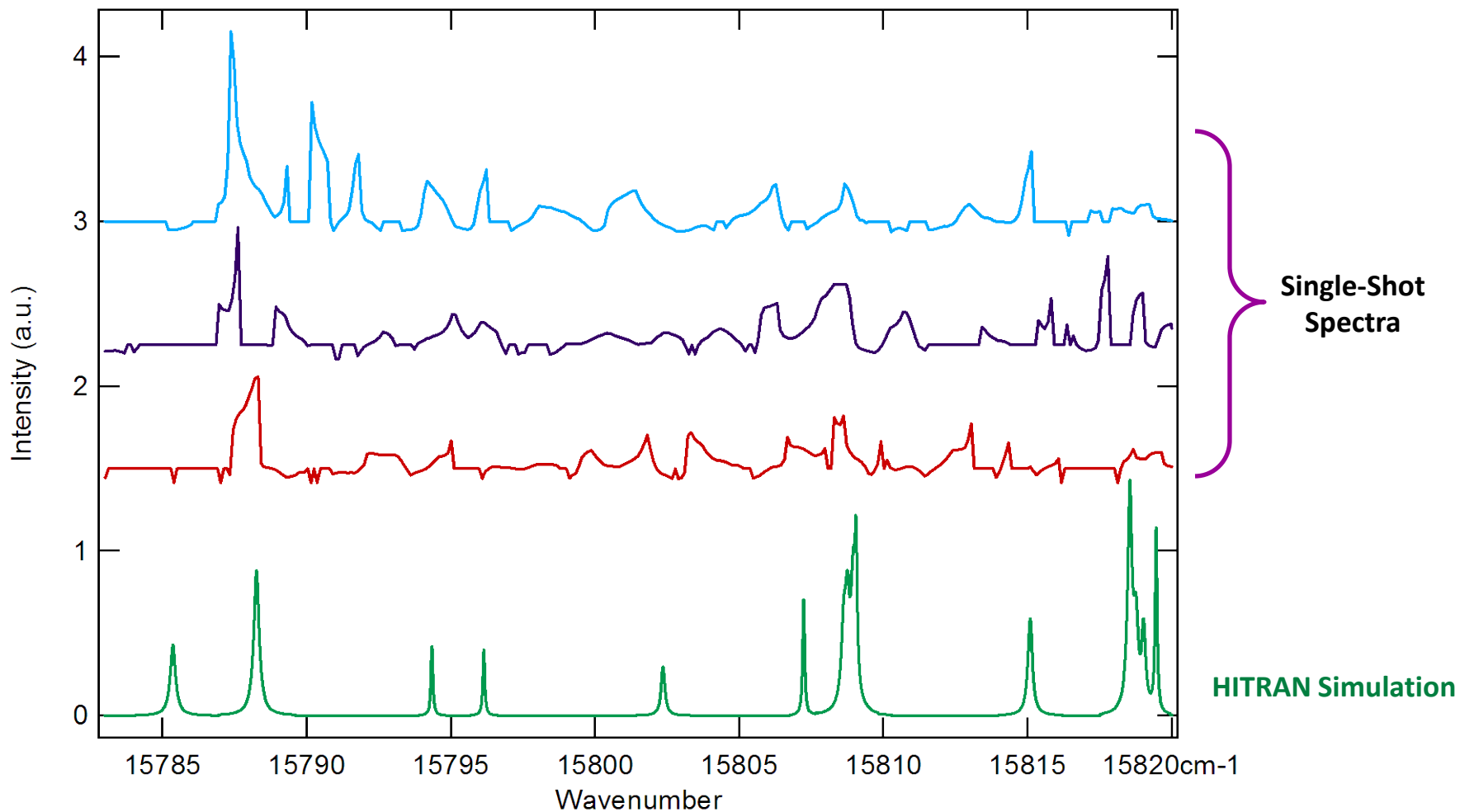

* Resolution limited by cavity decay constant

Spectral Resolution

- Ultimate spectral resolution limit determined by etalon FSR
- However, ability to resolve beat frequencies is limited by ring-down times (Fourier transform resolution determined by time window)
- Assuming cavity decay constant sets resolution, for $\tau = 75$ ns:
 - Fourier transform resolution: 13 MHz
 - Corresponding spectral resolution: 0.95 cm^{-1}

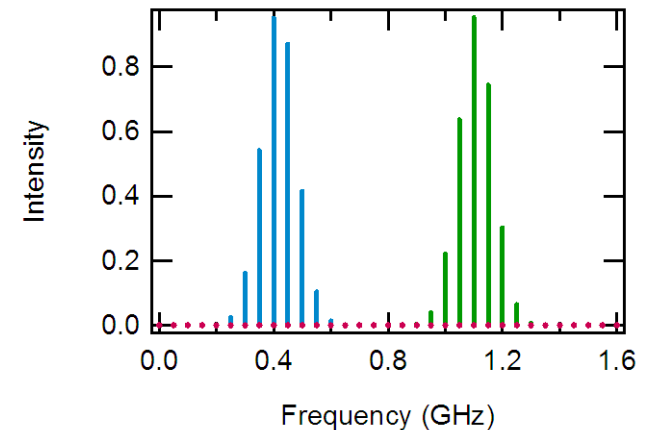
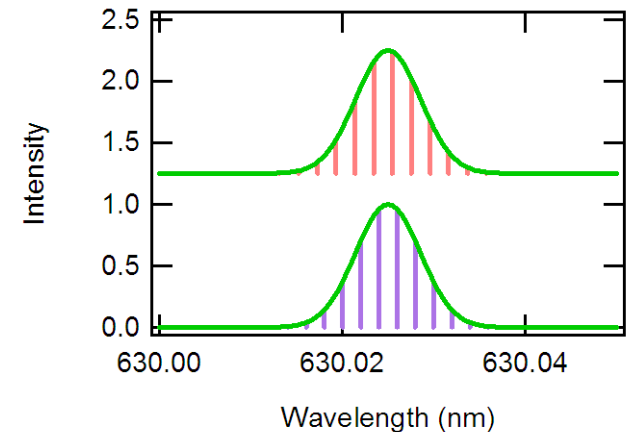

Experimental Setup II

Setup Comparison

		Setup I	Setup II
Laser	Wavelength	633 nm	629 nm
	Pulse energy	10 mJ	3 mJ
	Pulse width	65 ps	6 ns
	Linewidth	25 cm ⁻¹	0.15 cm ⁻¹
Cavities	Length	10 cm	50 cm
	FSR	1.5 GHz	300 MHz
	Δ FSR	700 kHz	240 kHz
	Mirror reflectivity	>99.5%	>99.99%
	Cavity decay constant, τ	75 ns	50 μ s
Detector		1.2-GHz photodiode	PMT

- Considerably smaller spectral region captured with single pulse
- Higher mirror reflectivity and longer cavity length results in longer decay constant, increased sensitivity, and higher spectral resolution

Results and Analysis

Combined Ring-Down Signal

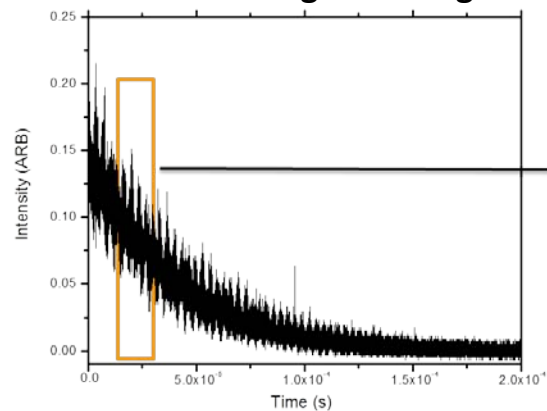

FFT of Ring-Down Section

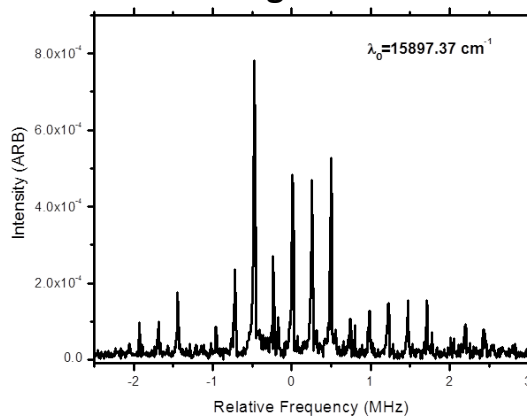

FSR: 300 MHz

Δ FSR: 240 kHz

N_{BF} in non-overlapped region: 625

Non-overlapped spectral width: 6.25 cm^{-1} (0.25 nm)

Fit decay signal to: $I(t) = I_0 \exp[-t (1/\tau + \alpha c)]$

Decay of Several Beat Frequencies for Two Laser Wavelengths

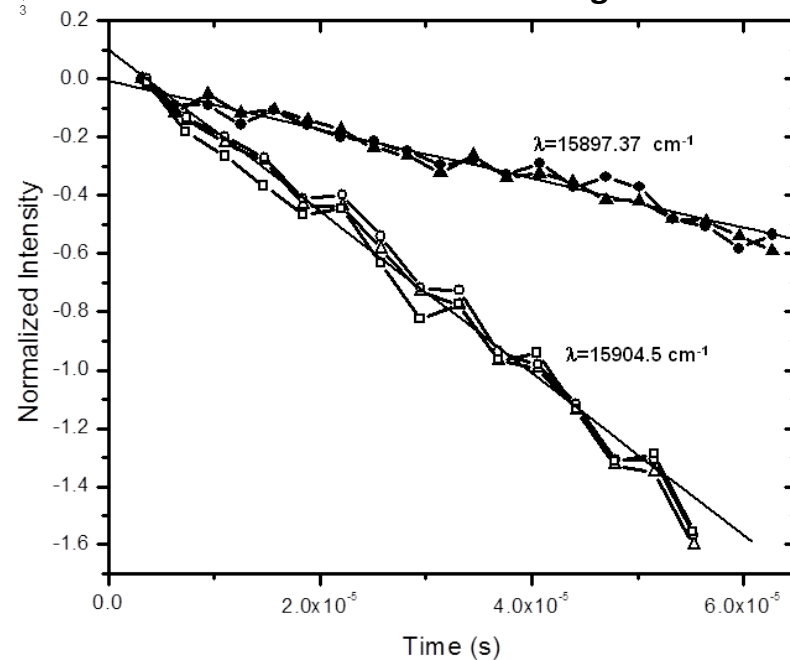

Absorption Spectra

- Traditional, laser bandwidth-limited CRDS:
 - Collect integrated signal as laser is scanned
 - Enabled identification of wavelengths to fix laser for single-pulse measurements

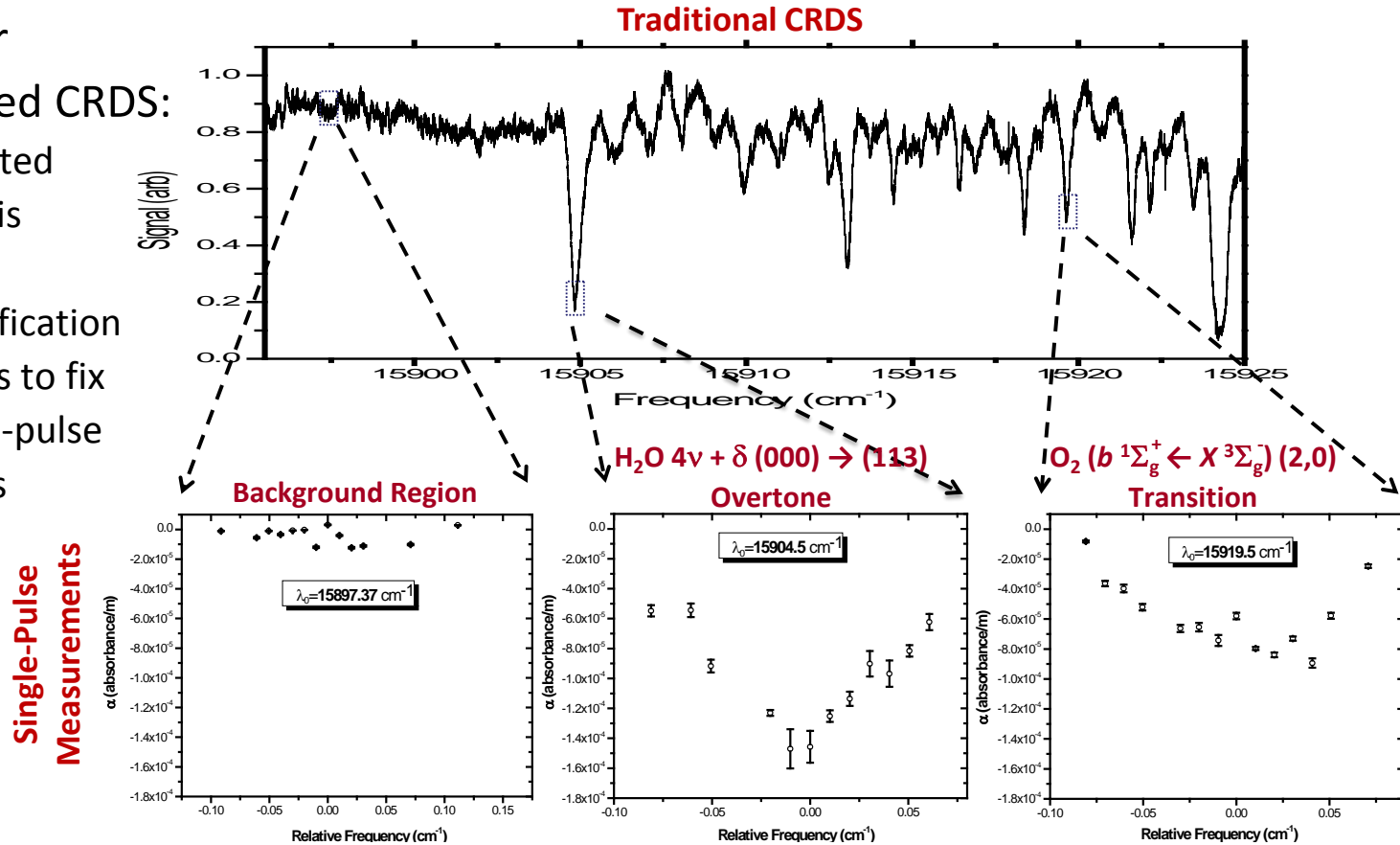

- Excellent agreement between observed spectra taken w/dual-etalon, frequency-comb spectrometer and that from the lower-resolution conventional CRDS method

- Motivation
- Dual-etalon, frequency-comb cavity ring-down spectrometer
- Proof-of-principle experiments: H_2O , O_2
 - Setup I: broadband laser, low-resolution cavity
 - Setup II: narrowband laser, high-resolution cavity
- Application to HCl detection
 - HCl spectroscopy
 - Component selection and next-generation dual-etalon spectrometer design
- Summary and next steps

HCl Spectroscopy

- Strong absorption features spanning 3.2-3.8 μm
- Simple, well-resolved spectrum

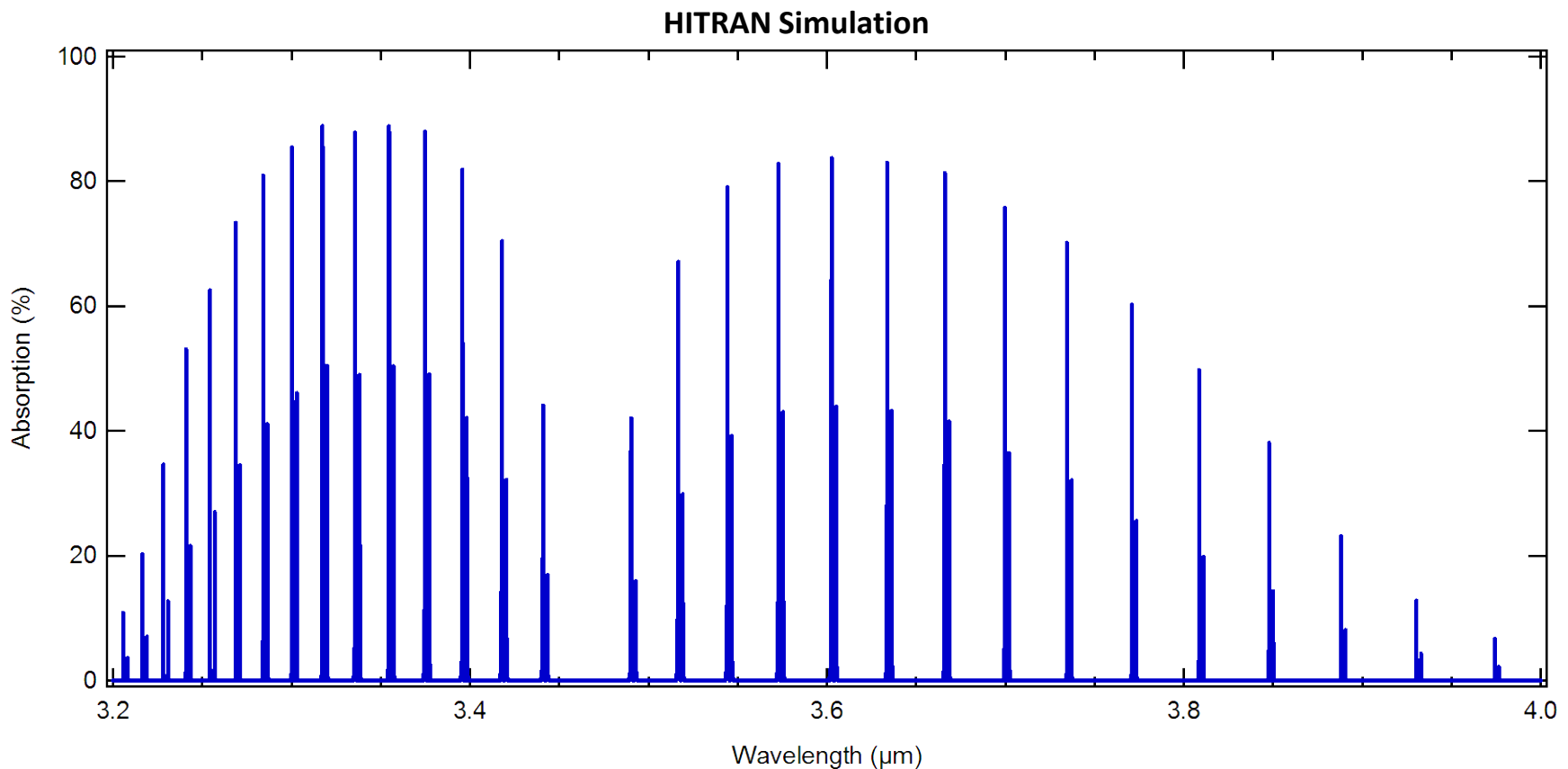

Non-Negligible Background Absorption

- HITRAN simulation assumptions:
 - Primary gas components: 6% H₂O, 4% O₂, 14% CO₂, 76% N₂
 - HCl concentration: 0.1 ppm
 - Additional species included (ex. SO₂, NO, NO₂)
 - Temperature: 200 °C
 - Path length: 100 m
- Primary background absorption from H₂O, and to a lesser extent CO₂

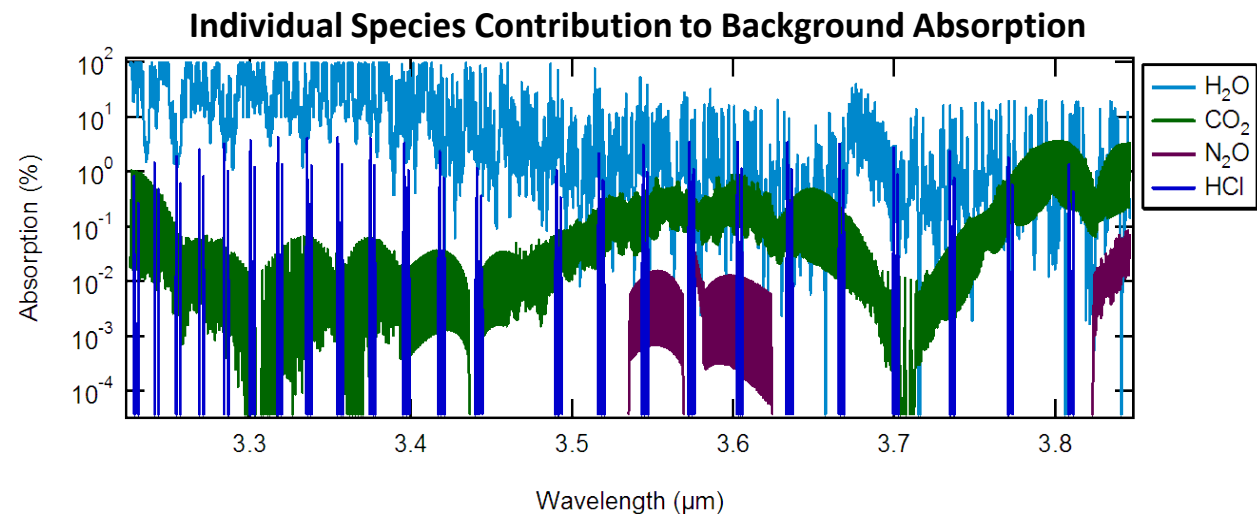
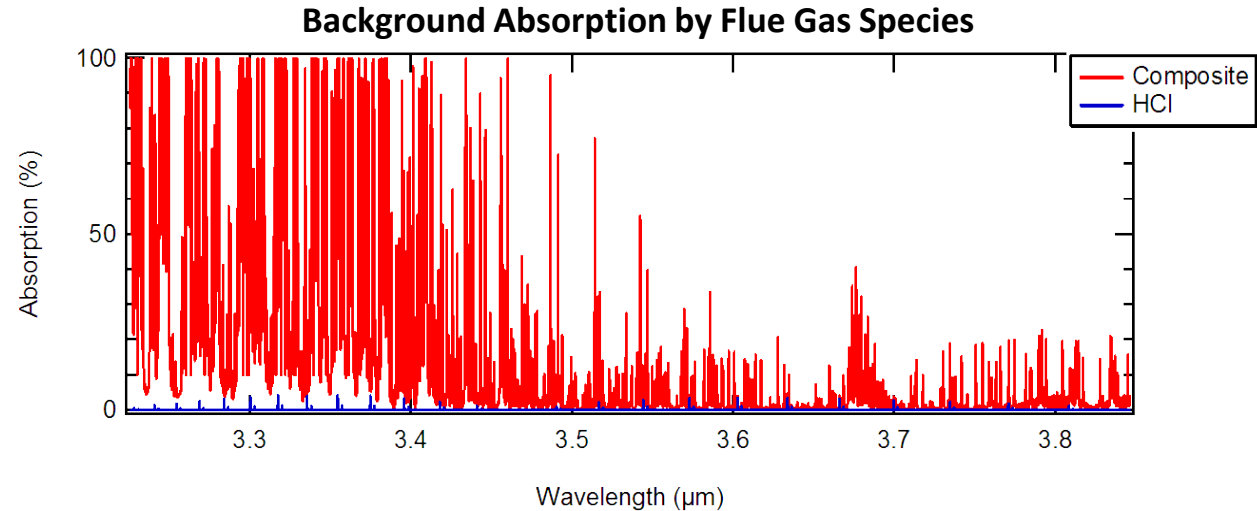

Discernible HCl Features Above Background

Ratio of Composite Spectra With and Without HCl

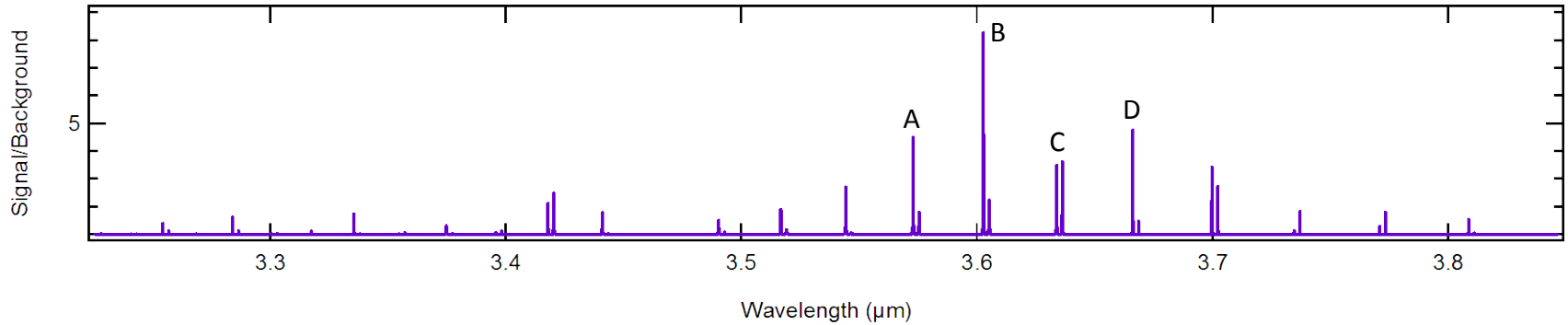

Comparison of Composite Spectra With and Without HCl

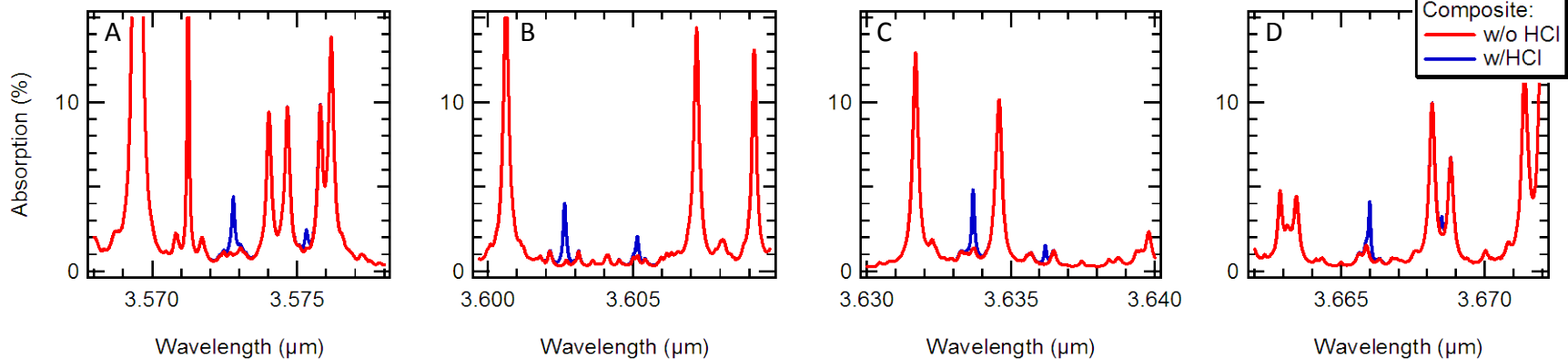

- With high-resolution spectrometer expect to be able to discern HCl above background

Absorption Path Length and Spectral Resolution

- Increased path length → greater absorption
- Increased ring-down time/cavity decay constant associated with a longer path length → higher resolving power in FFT
- Calculate spectral resolution assuming:
 - FSR: 150 MHz → maximum spectral resolution: 0.005 cm^{-1}
 - ΔFSR : 100 kHz
 - Path length-limited spectral resolution = (FFT resolution) x $\underbrace{(\text{FSR} / \Delta\text{FSR})}_{\text{rf frequency} \rightarrow \text{wavelength conversion}}$

Path Length (m)	Ring-down time (μs)	FFT Resolution (MHz)	Spectral Resolution (cm^{-1})	Spectral Resolution Limitation
50	0.17	6.0	0.3	path length
500	1.7	0.6	0.03	path length
5000	17	0.06	0.005	etalon FSR

Absorption Path Length vs. HCl Signal/Background

- Simulate absorption spectra with and without HCl for calculated spectral resolutions
- Increasing path length/increasing spectral resolution:
 - Initially improves ability to distinguish HCl features above background
 - At longer path lengths, background absorption dominates the spectra, lowering the signal/background ratio
- Feature B optimum path length
 - ~500 m (1.7- μ s ring-down time)
 - Signal/background: ~17

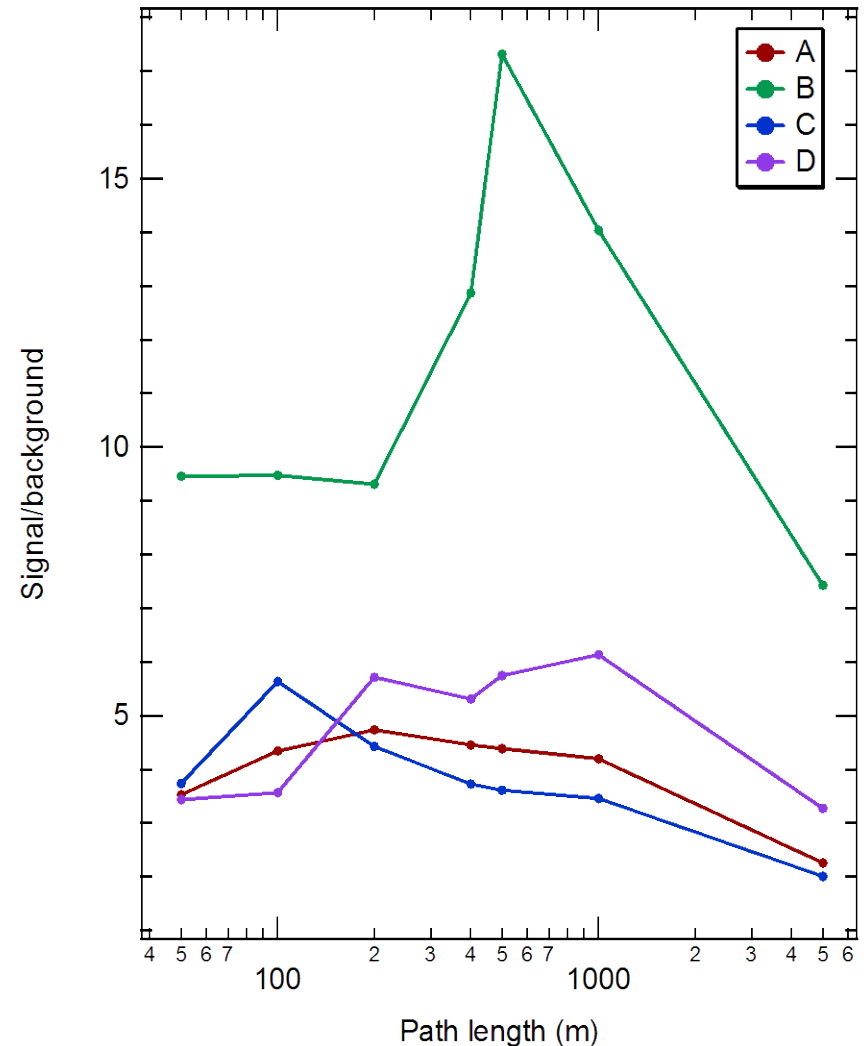

Experimental Setup – Laser Source

- Custom-built Nd:YAG-pumped OPO/OPA
- Pump laser: Continuum Surelite
 - Pulse energy: 500 mJ
 - Pulse width: 9 ns
 - Repetition rate: 10 Hz
- OPO/OPA
 - Measured pulse energy at 3.6 μm : 15 mJ
 - Bandwidth: estimate based on phase matching conditions
 - Seeded pump: 2 cm^{-1}
 - Unseeded pump: 19 cm^{-1}

Generation of 3.6 μm

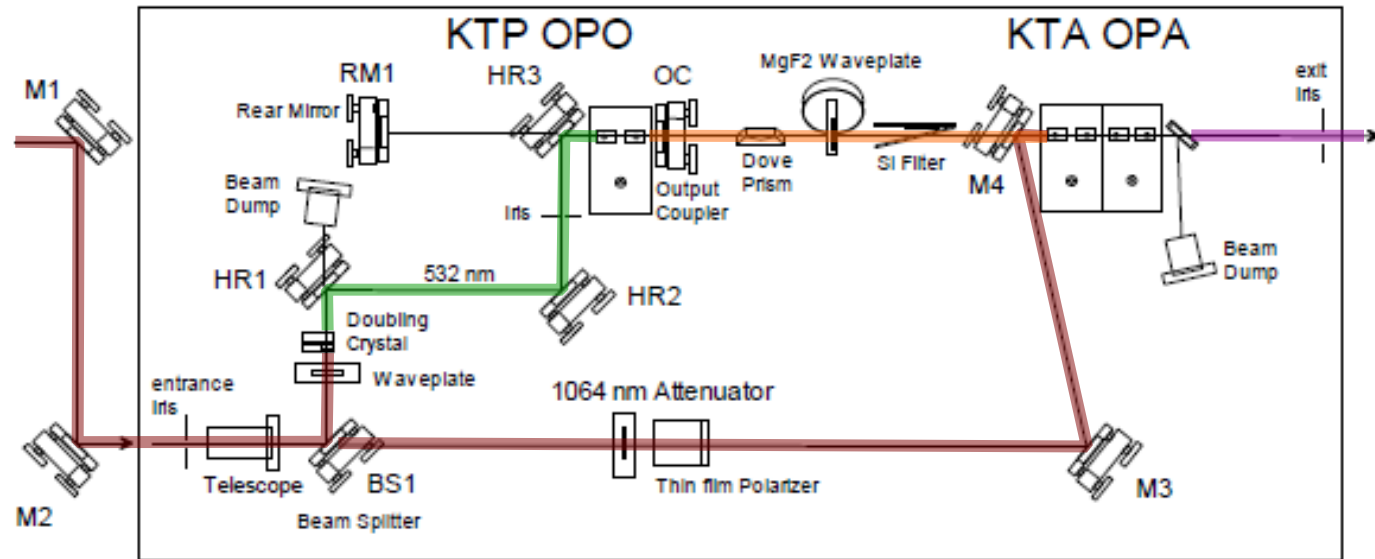
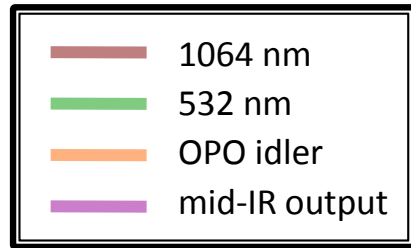

- OPO:
 - Pump λ : 532 nm
 - Crystal: KTP, type II phase matching
 - Output: tunable signal light over 710-885 nm
- OPA:
 - Pump λ : 1064 nm
 - Seed: idler from OPO
 - Crystals: KTA, type II phase matching, walk-off compensating geometry
 - Output: tunable mid-IR light over 1.35-5 μm via difference-frequency mixing

Experimental Setup – Monolithic Dual-Etalon Assembly

- Primary goals:
 - Minimize thermal variations between two cavities, which adds considerable complexity to the data analysis and increases measurement uncertainty
 - Independent adjustment of cavity mirrors to enable precise alignment, ensuring maximum ring-down times
- Additional features:
 - Multiple gas/vacuum access points
 - HCl-resistance
 - Stable, rugged unit
- Cavity length: 1 m
 - FSR: 150 MHz
 - Spectral resolution limit: 0.005 cm^{-1}

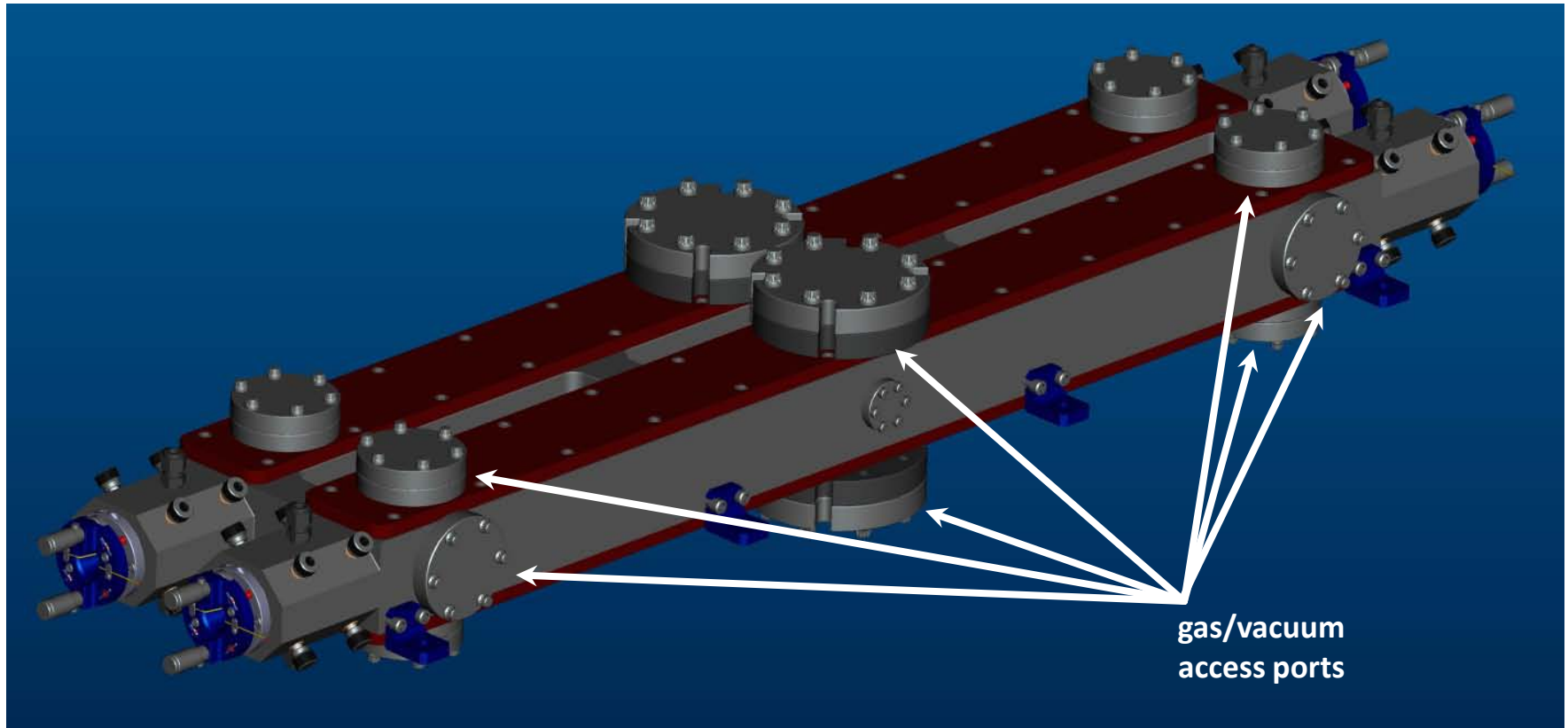

- Two etalon cavities thermally coupled
- Multiple conflat flanges for gas/vacuum line access
- 0.5"-diameter cavity mirrors contained within an adjustable insert

Design – Cut-Away Views

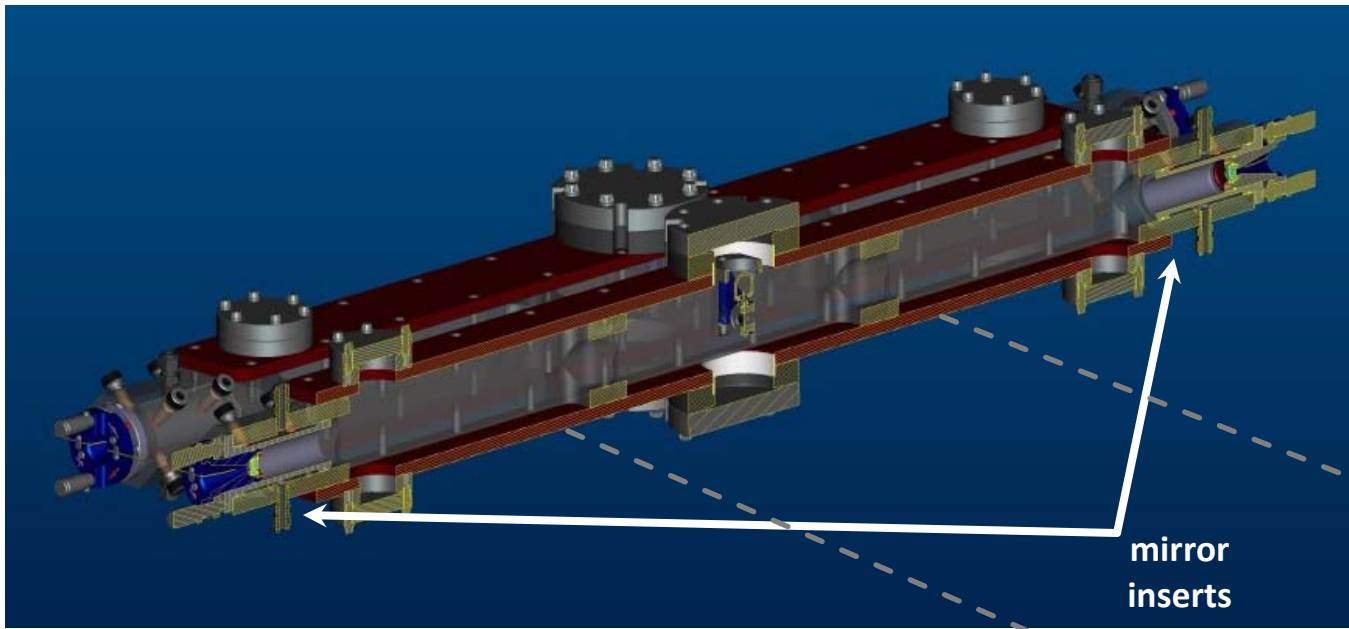

- Concentric cavity arrangement:
 - Fundamental mode of the cavity focuses tightly at the cavity center for both path directions
 - Aperture incorporated at this focus will reduce contribution of higher order modes to the observed signal → reduction in data uncertainty

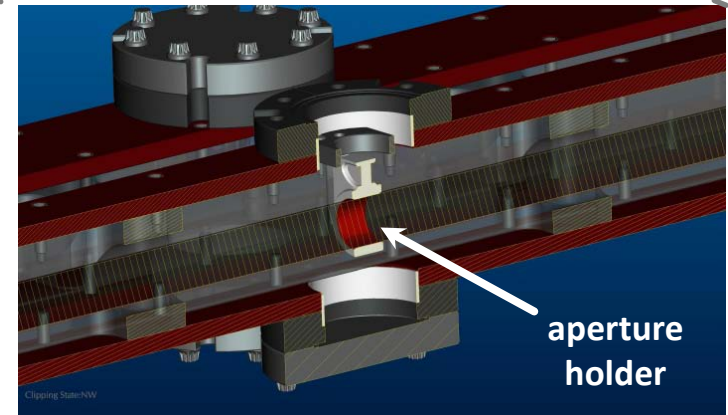

Design – Mirror Insert

Top View

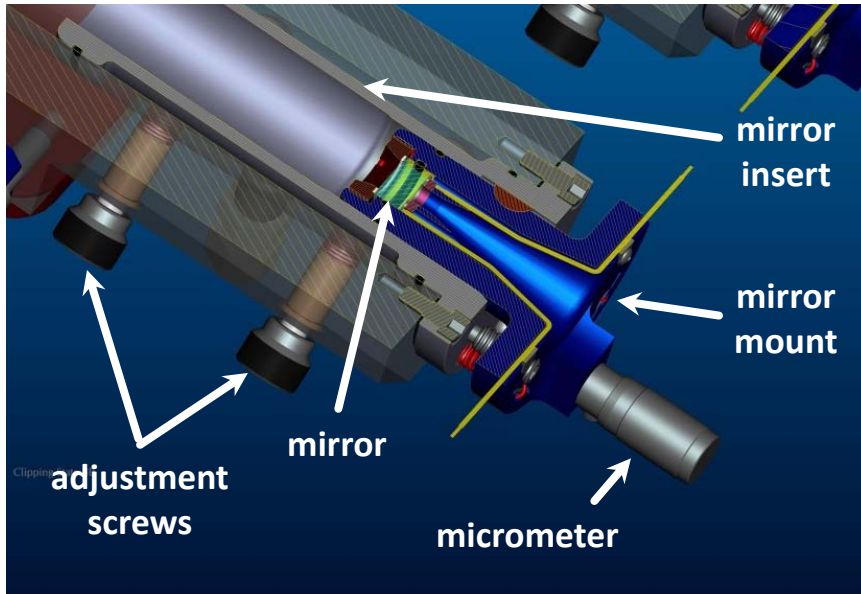

End View

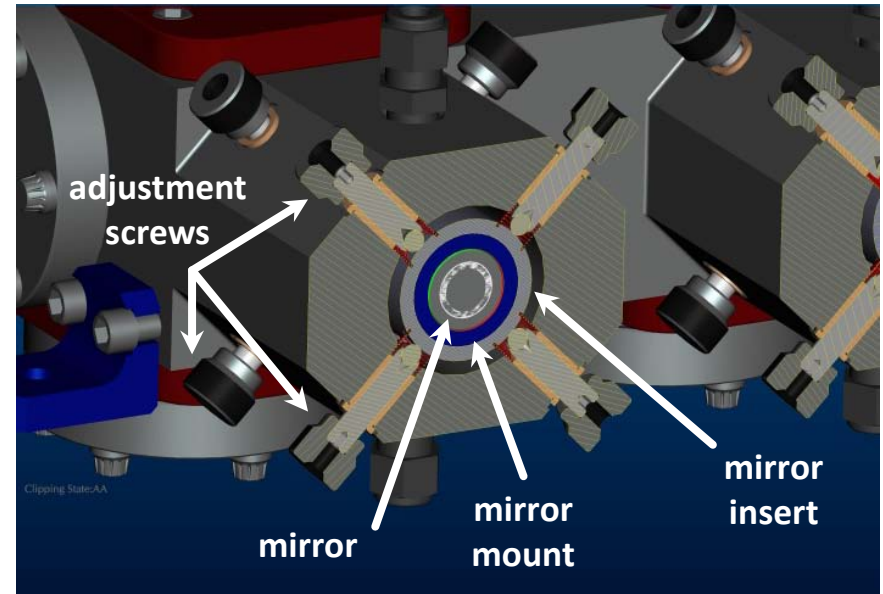

- Mirrors mount housed within an insert
- Mirror insert can be translated and angled slightly within cavity bore via adjustment screws
- Micrometer provides additional tip/tilt control of the mirror mount within the insert

Experimental Setup – Additional Key Components

- Cavity mirrors
 - Concentric configuration: 0.5-m radius of curvature
 - Confocal configuration: 1-m radius of curvature
 - Reflectivity: 99.98%
- Fluoride glass fiber
 - Transmission range: 0.3-4.5 μm
 - Typical loss: <0.2 dB/m at 3.6 μm
- Detector: InSb photodiode
 - Rise time: 3 ns
 - Bandwidth: 120 MHz
 - Requires liquid N₂ cooling

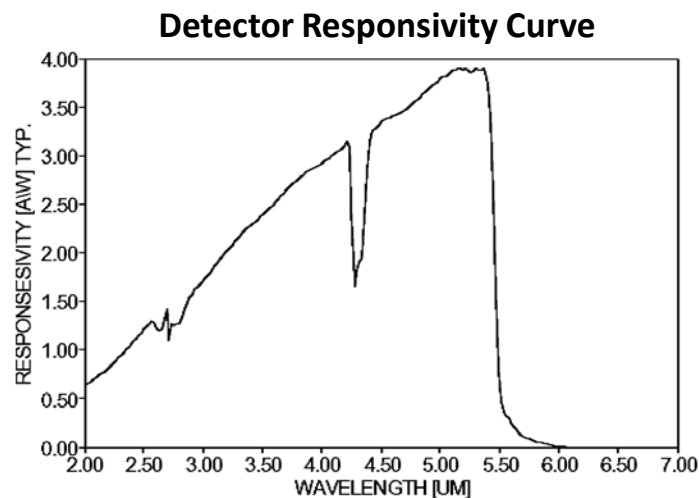

- Motivation
- Dual-etalon, frequency-comb cavity ring-down spectrometer
- Proof-of-principle experiments: H_2O , O_2
 - Setup I: broadband laser, low-resolution cavity
 - Setup II: narrowband laser, high-resolution cavity
- Application to HCl detection
 - HCl spectroscopy
 - Component selection and next-generation dual-etalon spectrometer design
- Summary and next steps

Summary

- Dual-etalon, frequency-comb cavity ring-down spectrometer is being developed at Sandia to generate a broad-bandwidth, high-resolution spectrum with the sensitivity of CRDS in a single laser pulse
 - Width of single-shot spectrum determined by laser bandwidth
 - Maximum spectral resolution set by etalon FSR, not laser linewidth
- The feasibility of this spectroscopic detection approach has been demonstrated with air
 - Developed data analysis tools
 - Lessons learned from initial proof-of-principle experiments incorporated in design of next-generation dual-etalon assembly
- Components for application to HCl detection at 3.6 μm have been obtained

Next Steps

- FY12
 - Assemble spectrometer for HCl detection
 - Evaluate HCl spectral signature
 - Quantify HCl detection sensitivity
 - Evaluate impact of primary flue gas constituents and potential spectroscopic interference species

- FY13-14
 - Couple dual-etalon, frequency-comb cavity ring-down spectrometer with flue gas from laboratory scale burner
 - Design and assemble a portable system

Contact Information

- Principle Investigator:
 - Alexandra Hoops
 - email: aahoops@sandia.gov

- NETL Project Manager:
 - Steven Seachman
 - Email: Steven.Seachman@netl.doe.gov